

Article number: 20146B40562BL

Description: E+G  
Flanged Connector GN 146-B40-56-2-BL

## Measures

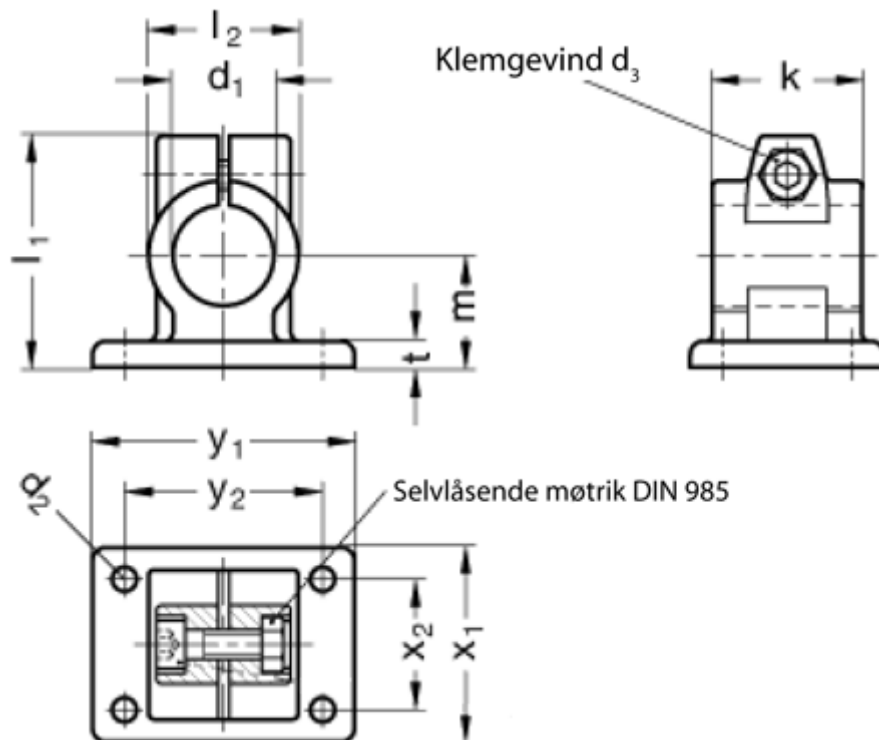

Adjustable clamp lever = GN 911-M10-40 have to be ordred separately

$d_1$  = B40  
 $d_2$  = 8.5  
 $d_3$  = M10  
 $k$  = 56  
 $l_1$  = 83  
 $l_2$  = 56  
 $m$  = 42

$t$  = 10  
 $x_1$  = 78  
 $x_2$  = 52  
 $y_1$  = 108  
 $y_2$  = 82